

oltre agli standard..

SPECIALI

by **samag**[®]

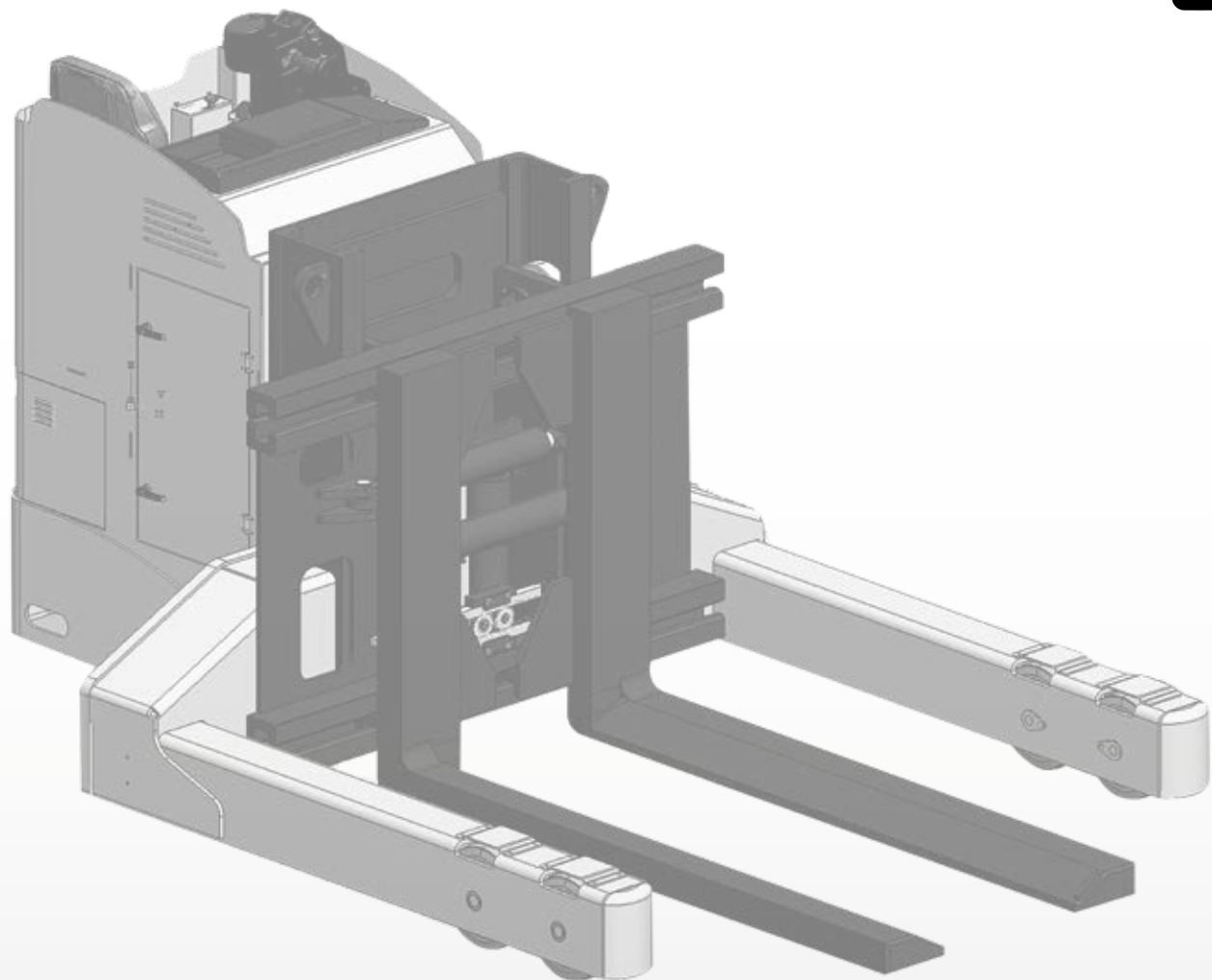

carrelli *speciali* per *movimentazione* interna

una storia cominciata più di 40 anni fa...

Samag nasce nel 1972 con l'obiettivo di coprire tutte le esigenze di movimentazione interna delle aziende, abbinando ad una gamma completa di carrelli per la movimentazione interna anche la progettazione e costruzione della gamma dei carrelli elettrici in acciaio INOX, completata in tutte le versioni per i vari utilizzi del settore dove la pulizia e l'igiene sono condizioni essenziali.



1972

la missione

Progettare e realizzare, in modo eccellente, prodotti capaci di soddisfare i bisogni e le idee delle persone e delle imprese.



oggi

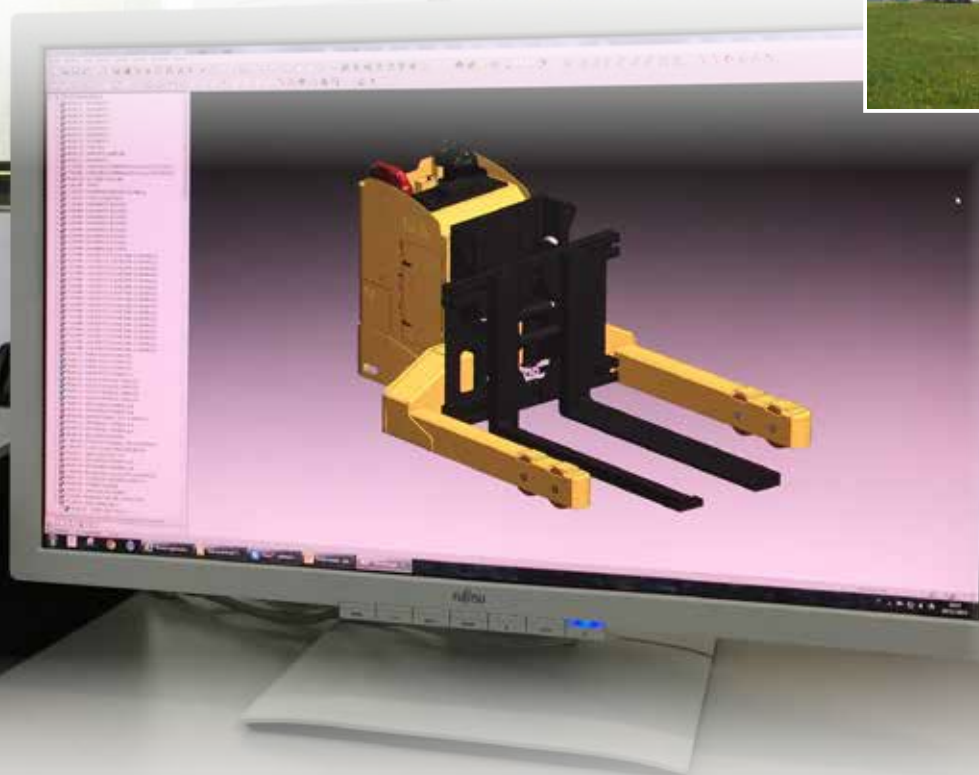

la visione

Sostenere lo sviluppo, sempre orientato all'innovazione, operando in base a principi di correttezza, responsabilità e trasparenza nei confronti dei clienti e fornitori.

la differenza

La costante ricerca tecnologica per migliorare sempre, l'ergonomia, le soluzioni tecniche, nel rispetto delle norme europee in fatto di sicurezza fin dalla loro emanazione.

La grande capacità di progettazione interna, permette a Samag di essere completamente indipendente nella realizzazione di componenti fondamentali come i montanti, i cilindri idraulici, i gruppi trazione. Un reparto di lavorazioni meccaniche all'avanguardia, dotato di centri di lavoro automatizzati e torni CNC, in cui si producono i componenti principali di tutti i carrelli.

Garantiamo infine il totale controllo sui cicli e sulla qualità del prodotto.

l'evoluzione internazionale

Pur essendo una realtà profondamente radicata nel territorio, Samag è riuscita, nel tempo, a diventare un partner affidabile e ricercato anche e soprattutto sul mercato internazionale: una capillare rete di vendita estera permette a Samag di essere competitiva e pronta ad affrontare le sfide della globalizzazione.



serie COMMISSIONATORI STANDARD

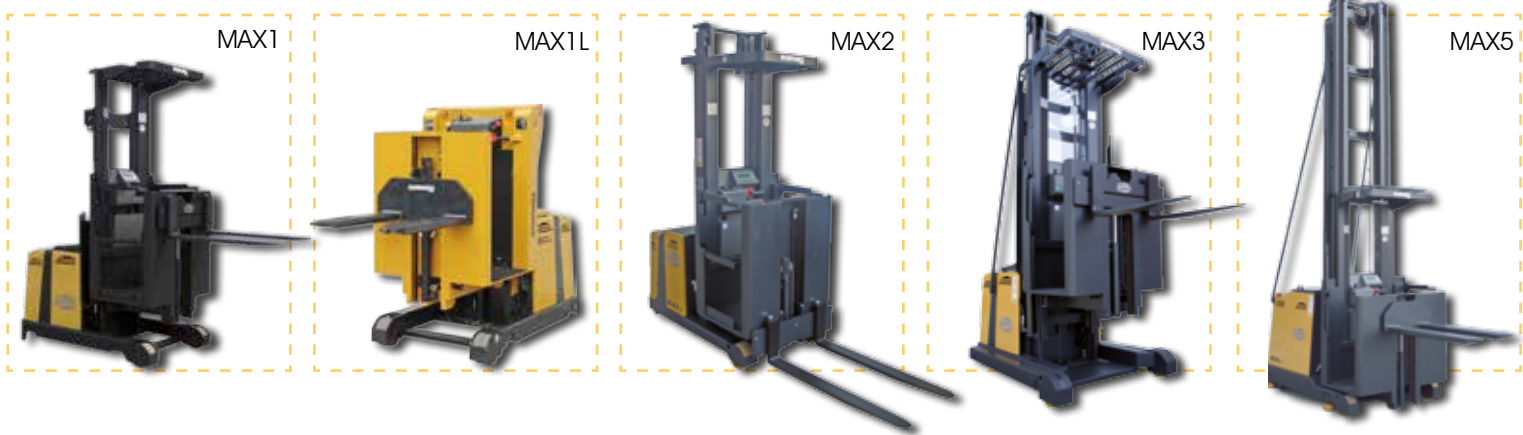

COMMISSIONATORI Speciali



serie TRASPORTATORI STANDARD

LOGIS



TM



TM PICK



TOP200



TOP220



TM con bilancia

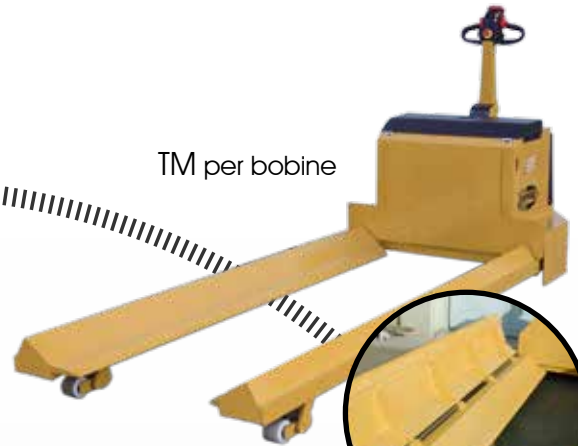

TM per bobine



doppia misura

TRASPORTATORI *Speciali*

TM con pianale



PICKING senza forche



TOP 22 porta bobine



serie ELEVATORI STANDARD



LOGIS PICK



EL



ELFO1



ELFO2



ERGON



TCS



SEL 5



EL con bilancia



ELFO con culle

ELEVATORI *Speciali*



EL con attrezzatura



ELFO con traino



EL con puntone



EL portabobine

serie INOX



TM INOX
con bilancia

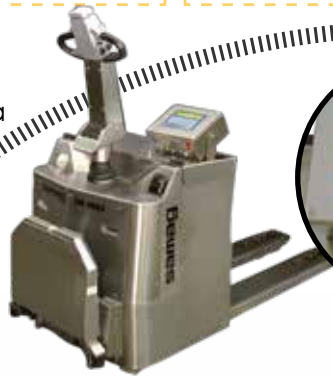

EL INOX
insaccati

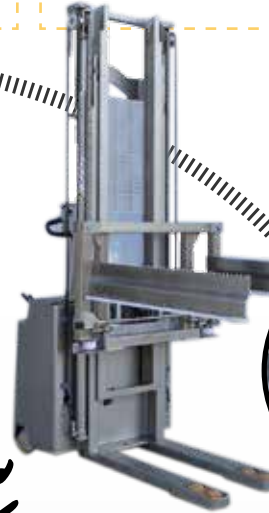

INOX *Speciali*



EGO INOX
sollevamento
senza catene



TOP INOX
speciale



BATTERIA AL LITIO SU RICHIESTA

METALLIZZATI *Speciali*



Serie LOGIS



Serie ELT
con forche INOX



Serie EL

serie PESANTE



TOP 15 T
15.000 KG
con pianale o forche

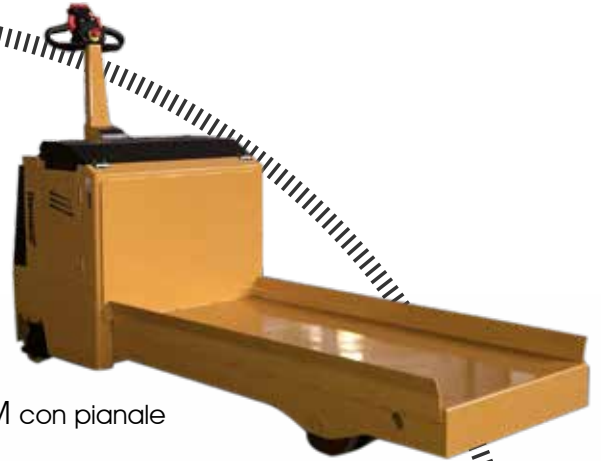
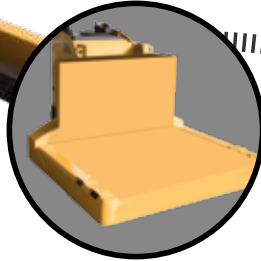

TM con pianale



TMTS

CARICHI PORTATE
Eccezionali



TM per bobine



EL



TOP Movimento autovetture

SPECIALI

by **samag**[®]

Innovazione, tecnologia, esperienza ci hanno permesso di realizzare linee di carrelli utili ad ogni vostra esigenza. Ricerchiamo responsabilmente la soluzione migliore per il trasporto merci. Benvenuti nel mondo Samag dove, ispirandosi alla filosofia del “Facile Trasportare”, realizziamo prodotti e servizi per il vostro lavoro.

Elena Rossetti

Massimo Rossetti